

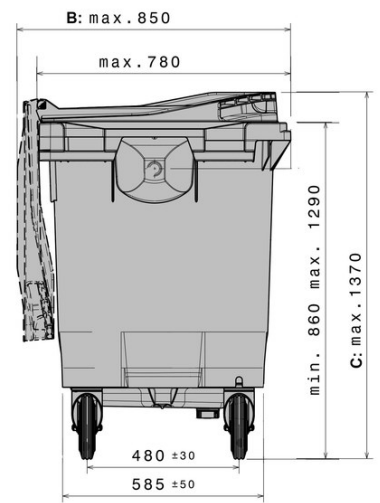

IP-MGBneo⁴/660l

660 L

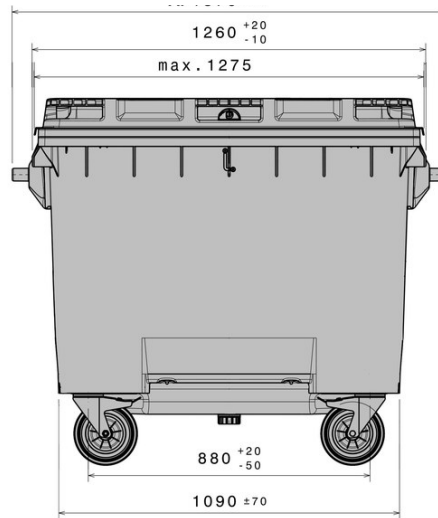

Art.No: IP-MGBneo⁴/660

Technical Data:

External dimension L x W x H mm:	A: 1370±10	B: max. 850	C: max. 1370
Volume (l):	660 l		
Material body, material lid:	PE/PE		
Holding capacity (kg)	 264 kg		
Available colours:	green, grey, blue, red, yellow		

Characteristics:

Container corresponds to:	EN 840, RAL-GZ 951/1
Travelling gear:	4 x Ø -200 mm castor wheels, standard equip with wheel stop
Receiver:	Comb lift
Prepared for transponder	Yes

Extra equipment / Accessories

Automatic lock
Directional lock for castor wheel
Triangular lock
Noise insulation plugs
Glas aperture

Loading quantities (Pcs / Approximate amount:)

On request

Labeling:

On the lid, on the body

*1) All specifications quoted are subject to change. We reserve the right to make changes to product design and specification. Dimension are stated according to DIN EN 840. Variations within the tolerances gives in the norm are possible.

*2) Extra equipment, accessories, as well as other colors are available at extra cost and on request

